

GARDiS Panel Mount Reader

The GARDiS Panel Mount Reader is compatible with industry standard 40x40mm panel cut-outs and can be mounted using the GARDiS Recess Box and Faceplate (5002-0493) which is available separately. The Reader contains an integral LED alongside a built-in sounder which gives an unambiguous feedback when a credential is presented.

The Reader has selectable output formats to allow connection to most Access Control Systems.

At a Glance

- Compatible with ISO 14443-A Standard
- Integral LED
- Built-in Sounder
- Selectable Output formats
- Recess Box and Faceplate also available
- Suitable for Outdoor use
- Offers high levels of vandal resistance



Reader Dimensions

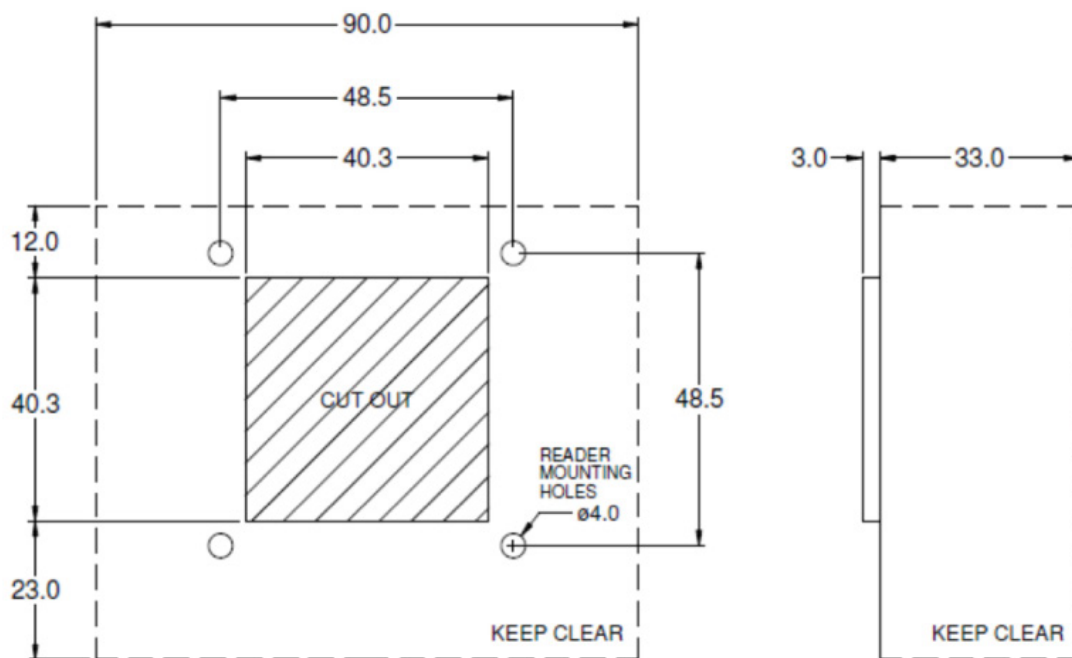

Specification

	GARDiS Panel Mount Reader
TDSi Part Number	5002-0618 (CSN Version), 5002-0638 (MIFARE DESfire Version)
Dimensions	107 x 71 x 27mm
Weight	60g
Card Technologies	ISO 14443-A; MIFARE DESfire, MIFARE Plus SL3, SL1, Classic
Read Range	<30mm - May vary between Cards and Installations.
Operating Environment	-20°C to +55°C, 0 to 95% RH (non-condensing)
Power Supply	7 to 14Vdc, 200mA (Max)
Sounder	Integral
LED	Integral
Output Formats	Magnetic Stripe, Wiegand 26-bit**/34-bit/37-bit

**Factory default, contact TDSi for alternative configurations.

Ordering Information

GARDiS Panel Mount Reader		
GARDiS Panel Mount Reader	Panel Mount CSN Reader	5002-0618
GARDiS Panel Mount Reader	Panel Mount MIFARE DESfire Reader	5002-0638
GARDiS Recess Box & Faceplate	GARDiS Recess Box & Faceplate for Panel Mount Reader	5002-0493

Recess Box and Faceplate (5002-0493) Dimensions

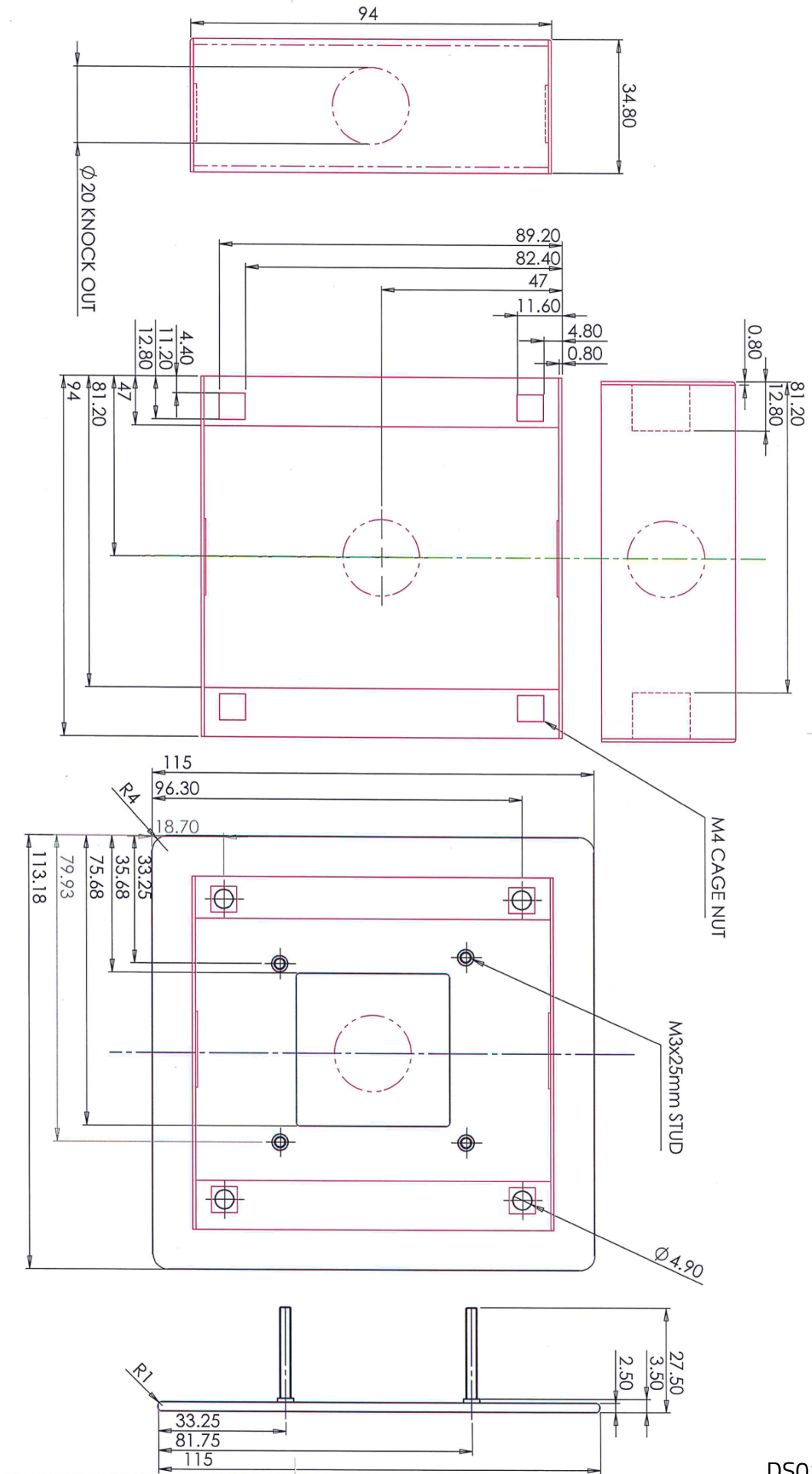

DS0178 - Issue 3